

We are seeking competitive bid proposals for construction of (5) three- or four-bedroom homes. Construction will begin April 2024.

Contract Items Available for Bid

- HFH-1A Building Materials
- HFH-3A Concrete
- HFH-6A Cabinets
- HFH-6B Interior Trim Finishing
- HFH-7A Roofing (labor only)
- HFH-8A Overhead Doors
- HFH-9A Drywall Finishing
- HFH-9B Flooring
- HFH-12A Appliances
- HFH-22A Plumbing
- HFH-22B Radon
- HFH-23A Ventilation
- HFH-23B Heating
- HFH-26A Electrical
- HFH-31A Earthwork
- HFH-32A Lawn Seeding
- HFH-32B Driveway
- HFH-33A Well

Bids must be delivered before 4 pm CST on Wednesday, February 14, 2024, to Habitat for Humanity of Douglas County, Attn. Office Manager, 1211 N Nokomis NE, Alexandria, MN 56308; phone 320-762-4255. A secure drop-box is available near the front door.

Successful bidders will be notified on or before Friday, February 23, 2024. Habitat reserves the right to reject any or all bids and to waive any informality in the bidding.

Bidding documents will be available for public inspection until bid opening time by visiting our website at hfhdouglascounty.org/events-news/bid-package or by calling the Habitat office at 320-762-4255.

Please email Construction Manager, Aaron Johnson aaron@hfhdouglascounty.org with any questions.



building homes, communities, and hope

Habitat for Humanity of Douglas County is a non-profit housing organization offering affordable homeownership and home repair programs for low-income people, families, and seniors who have lived or worked in Douglas County, MN for at least one year.



We build strength, stability, self-reliance *and* shelter.

January 24, 2024

Dear Build Partner,

We truly appreciate your interest in bidding on our 2024 build projects! Beginning in April, we look forward to building with five families and completing 25 Aging in Place projects.

Habitat Douglas County is fortunate to have many of our skilled contractors and subcontractors donate all or a portion of their time and/or materials to contribute toward the building of these homes.

The in-kind donations of labor and materials we've received have been a blessing to our work. We encourage you to consider how you may be able to help by listing your in-kind gifts of material and labor on the proposal bid form.

Your support would help serve more families in our community build a decent place to call home.

Thank you for your interest in partnering with us. Please feel free to contact us with any questions you may have.

Sincerely,

A handwritten signature in cursive script that reads "Lori Anderson".

Lori Anderson
Executive Director

Together we build...



STRENGTH



STABILITY



SELF-
RELIANCE



SHELTER

00 11 13 – INVITATION TO BID

Habitat for Humanity of Douglas County seeks competitive bid proposals for construction of (5) three- or four-bedroom homes. Construction will begin April 2024.

This project may include, but is not limited to, the following individual bid packages for:

- HFH – 1A Building Materials
- HFH – 3A Concrete
- HFH – 6A Cabinets
- HFH – 6B Interior Trim Finishing
- HFH – 7A Roofing (labor only)
- HFH – 8A Overhead Doors
- HFH – 9A Drywall Finishing
- HFH – 9B Flooring
- HFH – 12A Appliances
- HFH – 22A Plumbing
- HFH – 22B Radon
- HFH – 23A Ventilation
- HFH – 23B Heating
- HFH – 26A Electrical
- HFH – 31A Earthwork
- HFH – 32A Lawn Seeding
- HFH – 32B Driveway Paving
- HFH – 33A Wells

Bids must be delivered before 4 pm CST on Wednesday, February 14, 2024, to HFH of Douglas County, Minnesota, Inc., Attn. Office Manager, 1211 N Nokomis NE, Alexandria, MN 56308. A secure drop-box is available near the front door.

Bidding Documents will be available for public inspection **on or after Wednesday, January 24, 2024,** at the following locations until bid opening time:

- On-line: hfhdouglascounty.org/events-news/bid-package
- HFH of Douglas County, Minnesota, Inc., 1211 N Nokomis NE, Alexandria, MN 56308
 - Phone (320) 762-4255

Printing costs for the plans and specs are the sole responsibility of the bidder. Successful bidders will be notified on or before Friday, February 23, 2024. HFH of Douglas County, Minnesota, Inc. reserves the right to reject any or all bids and to waive any informality in the bidding.

To be considered, your sealed bid must include the following information:

- Signed and Dated Proposal of Bid Form (as noted in bid instructions).
- Contractor's License # and mailing address.
- Completed W-9.
- Certificate of Insurance for General Liability and Workers' Compensation listing HFH of Douglas County, Minnesota, Inc., 1211 N Nokomis NE, Alexandria, MN 56308 as certificate holder.
 - In the event a single employee/owner subcontractor does not carry Workers' Compensation Insurance, the following form must be completed: "Determination of Independent Contractor Status for Workers' Compensation Insurance Coverage."

END OF SECTION 00 11 13

SECTION 00 21 13 – INSTRUCTIONS TO BIDDERS

00 21 13 INSTRUCTIONS TO BIDDERS

The following instructions and information apply to all Contract Divisions. Failure to comply may be cause for rejecting Bids. Refer also to the Invitation to Bid, Section 00 11 13, General Conditions and Supplemental Conditions.

1. BIDS:

This is a Construction Management Project. There is no General Contractor. All Contractors on this project are considered Prime Contractors. The Owner will award separate Contracts for all Bid Divisions involved in the project. The Project will be administered by the Construction Manager. Bid package Bids will be received by the Construction Manager at the time and place designated in the Invitation to Bid (Section 00 11 13).

2. PRE-BID:

Please contact Construction Manager, Aaron Johnson at (320)762-4255 or aaron@hfhdouglascounty.org with any questions.

3. DOCUMENTS FOR BIDDING:

Complete sets of Bidding Documents may be examined or obtained in the manner described in the Invitation to Bid, Section 00 11 13. Complete sets of documents shall be used in preparing Bids; neither the Owner or Construction Manager assume any responsibility for errors or misinterpretations resulting from the use of incomplete sets of Bidding Documents.

Bid Division Description – For clarification purposes the scope of the work involved in each Bid division is defined in three categories: “EXCLUDED”, “INCLUDED” and “ALSO INCLUDED”. Information provided under the heading “EXCLUDED” is for the purpose of noting a point of beginning and/or to eliminate fringe involvements that might be inadvertently included in the scope of work. Information under this heading is not always required to define a Bid Division. “INCLUDED” items are the obvious and/or “conventional” work scope of a Bid Division. Information under “ALSO INCLUDED” points out the “unconventional” and/or less obvious items of work included in the Bid Division, as well as the fringe involvements that could inadvertently be missed in evaluating the scope of the work. Information under this heading is not always required to define a Bid Division.

4. QUALIFICATIONS OF BIDDERS:

The owner reserves the right to reject any Bid if the evidence submitted by, or investigation of, such Bidder fails to satisfy the Owner that such Bidder is properly qualified to carry out the obligations of the Agreement and to complete the Work contemplated therein.

5. EXAMINATION OF BIDDING DOCUMENTS AND SITE:

Before submitting a Bid, each Bidder must (a) examine the Bidding Documents thoroughly, (b) visit the site to familiarize himself/herself with local conditions that may in any manner affect cost, progress, or performance of the work, (c) familiarize himself/herself with federal, state and local laws, ordinances, rules and regulations that may in any manner affect cost, progress or performance of the work; and (d) study and carefully correlate Bidder's observation with the Bidding Documents.

6. INTERPRETATION:

If any person contemplating submitting a Bid is in doubt as to the true meaning of any part of the Drawings, Specifications or other Bidding documents or finds discrepancies in or omissions from the Drawings or Specifications, a written or email request for an interpretation, clarification or correction thereof may be submitted to the Construction Manager. Any inquiry received at least seven (7) working days prior to the date fixed for opening of Bids will be given consideration. The person submitting the request will be responsible for its prompt delivery. Any interpretation, clarification or correction of the documents will be made only by

Addendum issued by the Construction Manager. A copy of the Addendum will be available at www.hfhdouglascounty.org and at the Habitat Office.

7. APPROVAL OF SUBSTITUTIONS:

Requests for approval of substitutions must be made in writing or via email to the Construction Manager and must be received at least seven (7) working days prior to the date set for receipt of Bids. The Construction Manager will issue a written Addendum listing the products approved not later than three (3) days prior to the Bid date. A copy of the Addendum will be available on-line at www.hfhdouglascounty.org and at the Habitat Office. The Contractor shall not furnish any substitute material, product, or equipment not so approved. If rejection of any such unapproved substitution causes a change in the supplier proposed, or removal of work in place, there shall be no increase in the Contract Sum allowed due to any increase in cost occasioned by such change or removal. Items receiving prior approval will be subject to final approval when the Shop drawing submittals are reviewed.

The Contractor shall be responsible for fit and clearances of substituted items and for making any modifications in their work or the work of other Contractors necessitated by the use of any substitution, without cost to the Owner or other affected Contractors.

8. ADDENDA:

Any Addenda issued during the time of bidding or forming a part of the Bidding Documents loaned to the Bidder for the preparation of this Bid shall become a part of the Contract. Addenda will not be issued later than three (3) working days prior to the date set for receipt of Bids. Receipt of each Addendum shall be acknowledged on the Bid Form.

9. TAXES, PERMITS AND FEES:

Tax Exempt Status: HFH of Douglas County, Minnesota, Inc. is a non-profit Corporation and carries a tax-exempt status. As such they have been granted a Certificate of Exemption. The certificate will be issued to Contract holders and **sales tax is not to be included in the proposal amount. The Minnesota Tax Number is 6861337.**

All building permits, blueprint review fees and state surcharges will be paid by the Owner. Fees for special local, state, or federal inspections relating to mechanical, electrical, conveying systems and similar installations shall be paid for by the Contractor or subcontractor to which such inspections apply.

10. BID FORM:

Each Division Bid shall be made on the appropriate Bid Division Form. **Note that the Bid amount is per house. Bidder must also complete the Proposal Bid Form – Section 00 41 23.**

There is no limit as to the number of Bid Divisions any one Contractor can Bid. Bidders shall provide a separate Bid for each Bid Division they are bidding. The Bidder may combine the Bids of separate Bid Divisions by providing a combined Bid deduct in the space provided on the Proposal Bid Form – Section 00 41 23. No other method for combining the work of more than one Bid Division will be accepted.

All blank spaces for Bid prices must be filled in, in ink or typewritten, and Bid Form must be fully complete and executed when submitted. (Pencil Bids or unreadable Bids shall be cause for rejection.) Bidder must note “N/A” in those blanks not applicable to their proposal. Only one copy of the Bid Form is required. The award of all Bid Divisions will be based on the dollar value of the proposal, the qualifications of the Contractor and the ability to perform.

11. IN-KIND DONATION:

Habitat for Humanity of Douglas County hopes you will consider making an in-kind tax-deductible donation as part of your bid. By making an in-kind donation of materials and/or labor, you make it possible

for us to serve more families in the future. Our homeowners work to build their home, and the homes of others and purchase their home with an affordable mortgage. These home payments help to build still more homes for other families in need. Your contribution is greatly appreciated but is not required. We invite you to visit www.hfhdouglascounty.org for more information about our mission and how your work can change lives here in Douglas County; or call (320) 762-4255 and we can answer any questions you may have.

12. BID MODIFICATIONS:

The Bid Form shall not contain any modifications of the work to be done. Alternate Bids will not be considered unless specified on the Bid. A conditional or qualified Bid will not be accepted.

13. ALTERNATES:

Bidder shall quote all Alternates as described in the Bidding Documents. The Owner reserves the right to reject all Alternates, or to accept Alternates in the sequence listed in the Bid Form at time of Contract award.

14. BID SIGNING:

Each applicable Bid Division Form and the Proposal Form shall be signed by the Bidding Contractor.

15. BID SUBMITTAL:

Each Bid shall be submitted in a sealed envelope and delivered before the time and date indicated above to: HFH of Douglas County, Minnesota, Inc., Attn: Office Manager, 1211 N Nokomis NE, Alexandria, MN 56308. It is the sole responsibility of the Bidder to see that their Bid is received by the proper time.

16. BID WITHDRAWAL:

Any Bidder may withdraw their Bid after it has been deposited with the Owner prior to the time of Bid opening provided the request for withdrawal is received prior to the date and time of opening.

17. BID OPENING:

Bids will be opened privately by HFH of Douglas County, Minnesota, Inc.

18. BIDS TO REMAIN OPEN:

All Bids shall remain open for the number of days designated in the Advertisement for Bids, but the Owner may, in their sole discretion, release any Bid prior to that date.

19. BID EVALUATION:

The Owner reserves the right to waive any informalities, minor defects, or irregularity and to accept or reject any and all Bids. The Owner reserves the right to award the Contract in any Building Division between two Bidders, one per home.

In evaluating Bids, the Owner shall consider the qualification of the Bidders; whether or not Bids comply with the prescribed requirements; and alternates, if requested in the Bid forms. The Owner may conduct such investigations as deemed necessary to assist in the evaluation of any Bid and to establish the responsibility, qualifications and final ability to the Bidder, proposed subcontractors and other persons and organizations to do the work. The Bidder acknowledges the right of the Owner to accept any combination of Bid Divisions the Owner desires. The Bidder represents that they will accept the award, regardless of who the other Bid Division contractors may be. If a Contract is to be awarded, it will be awarded to the Bidder whose evaluation by the Owner indicated that the award is in the best interest of the Owner. Should there be reasons why the Contractor cannot be awarded within the specified time for Bids to remain open, the time may be extended by mutual agreement between the Owner and the Bidder.

20. NOTICE OF AWARD:

If a Bid is accepted by the Owner, the Bidder's Proposal Bid Form will be signed by the Owner and will

constitute the Contract. A copy of the Contract will be forwarded to the Bidder. This Bidder shall be required to execute the Contract and provide all Project Insurance coverage and necessary forms prior to commencement of work. In case of failure of the Bidder to execute the Contract or provide necessary Project Insurance coverage and necessary forms, the Owner may consider the Bidder in default; in which case the accompanying proposal shall become the property of the Owner and the Contract shall be null and void.

21. FORM OF AGREEMENT:

Contract will be executed on Proposal Bid Form – Section 00 41 23.

22. PROJECT INSURANCE:

The Contractor shall purchase and maintain insurance for this project in accordance with the General Conditions and Supplementary Conditions. The Contractor shall file an acceptable Certificate of Insurance and insurance policy with the Owner prior to commencement of work under the Contract.

23. NOTICE TO PROCEED:

The Notice to Proceed shall be issued within ten (10) days of the execution of the Agreement by the Owner. Should there be reasons why the Notice to Proceed cannot be issued within such period, the time may be extended by mutual agreement between the Owner and the Contractor.

24. CONSTRUCTION SAFETY POLICY:

It is our policy to provide a safe and healthful workplace for our employees and volunteers, to observe all state and federal laws and regulations, and to provide an environment as free as possible from recognized hazards. We have and will continue to maintain and implement a comprehensive employee and volunteer injury and illness prevention program.

SECTION 00 72 00 – GENERAL CONDITIONS

- All work shall be performed, and all deliveries made in coordination with other contractors, Habitat Site Supervisors and according to a final Build Schedule to be made available from Habitat prior to start of construction.
- Habitat will obtain applicable city, township, or county Building Permit(s). All other permits, fees and expenses incidental to items and work listed above are the responsibility of the Bidder and shall be included under the Contract amount.
- All scrap, containers, excess materials, and miscellaneous debris resulting from work under this Contract shall be removed from the premises or placed in the appropriate on-site dumpster to be furnished by Habitat. Recyclable materials, i.e., cardboard, steel, aluminum, and beverage containers shall not be placed in the construction dumpster.
- All product instruction manuals and warranty information shall be retained and left at the home site for the future homeowner.
- Individuals working as independent contractors must hold an Independent Contractor Exemption Certificate (ICEC) and must furnish evidence of same at time this proposal is submitted.
- Prior to awarding contracts, selected Contractor shall submit Certificate of Insurance for General Liability and Workers Compensation (in the event a single employee/owner subcontractor does not carry Workers Compensation Insurance an additional form is required), listing HFH of Douglas County, Minnesota, Inc., 1211 N Nokomis NE, Alexandria, MN 56308 as certificate holder.
- Current W-9 forms shall be included with Form of Proposal.
- Tax-Exempt Status: Habitat is a non-profit Corporation and carries a tax-exempt status. As such they have been granted a Certificate of Exemption. The certificate will be issued to Contract holders, and sales tax is not to be included in the proposal amount. The Minnesota Tax Number is ES36406.
- Habitat requires lien waivers to be submitted with all requests for payment.
- Invoices shall be paid in a timely manner.

END OF SECTION 00 72 00

SECTION 00 31 00 – SPECIAL CONDITIONS AND SCHEDULE

1. PART 1 – GENERAL

1.1 SCOPE

- A. Conditions of the Contract, Division 0, and General Requirements, Division 1, will govern work under this Section.
- B. The following Special Conditions modify, define, change, delete from, add to and take precedence over certain provisions of the General Conditions of the Contract for Construction, and Supplementary General Conditions.

1.2 TIME OF COMPLETION

- A. The contract shall be substantially completed in the timeframe determined by the Construction Manager.
- B. See the Schedule in Part 2. The actual Schedule will be determined by the Construction Manager.

2. PART 2 – SCHEDULE

The below schedule is a high-level timeline. A Build Schedule which overviews all the activities inherent in the home construction will be shared after bid selection. The schedule is subject to change as conditions require.

House #	1	2	3	4	5
Start Date	4/12/2024	5/10/2024	6/7/2024	8/19/2024	9/27/2024
Completion Date	8/30/2024	9/27/2024	10/25/2024	5/15/2025	1/31/2025

END OF SECTION 00 31 00

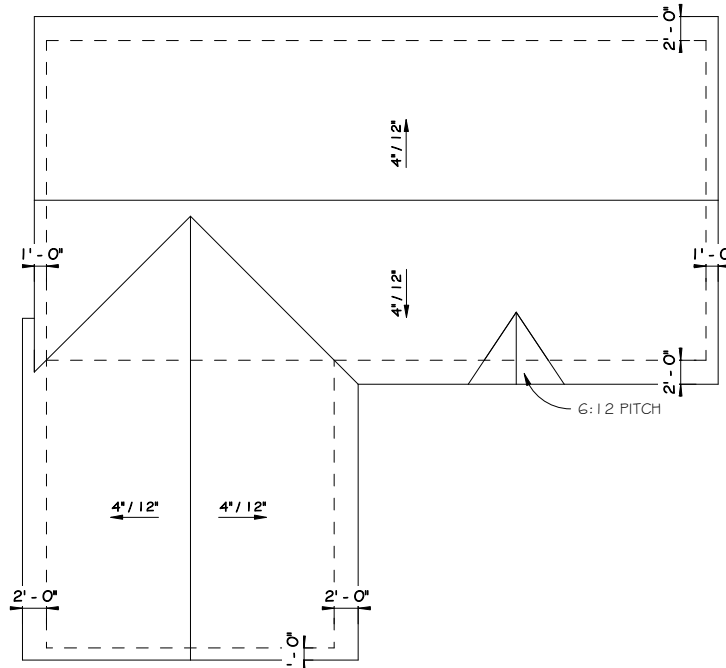

5 ROOF PLAN
A1 1/8" = 1'-0"

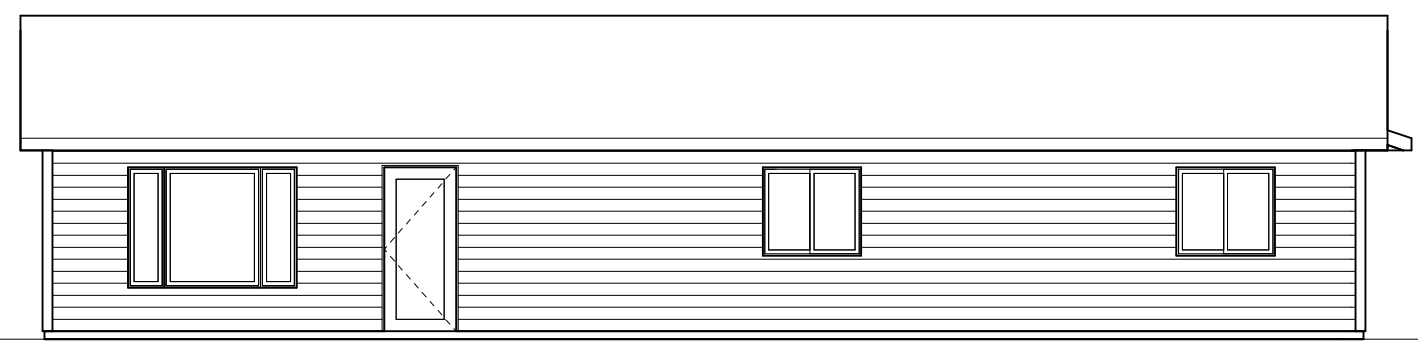

1 REAR
A1 1/4" = 1'-0"

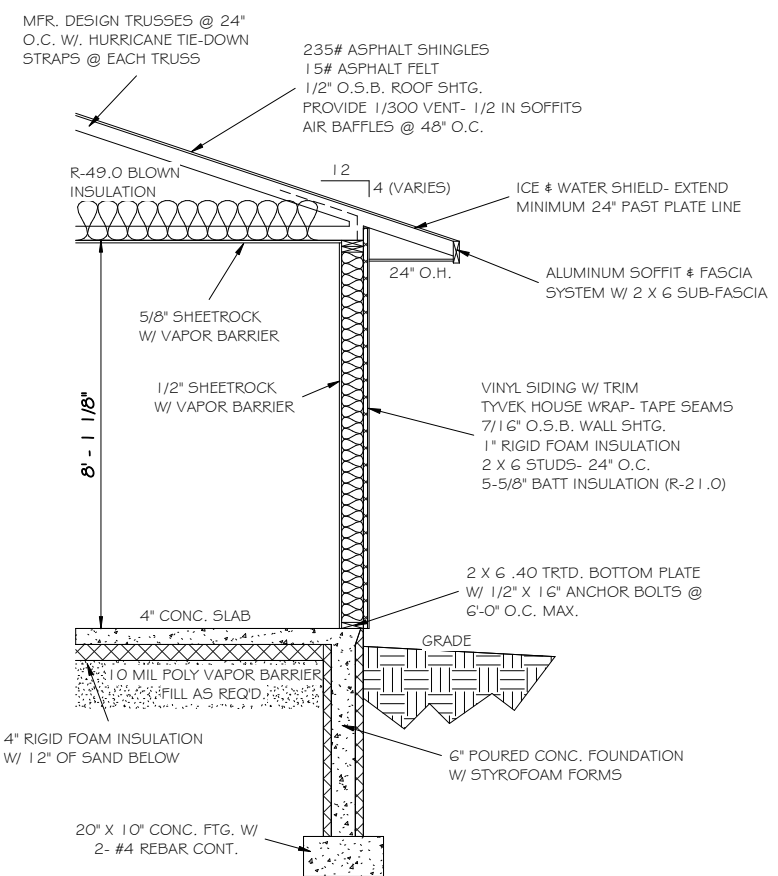

6 - Wall Section
A1 1/2" = 1'-0"

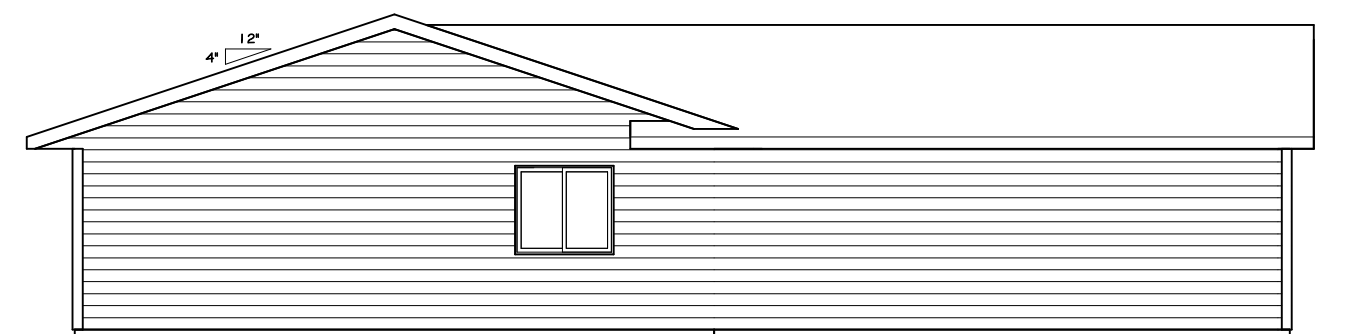

3 LEFT
A1 1/4" = 1'-0"

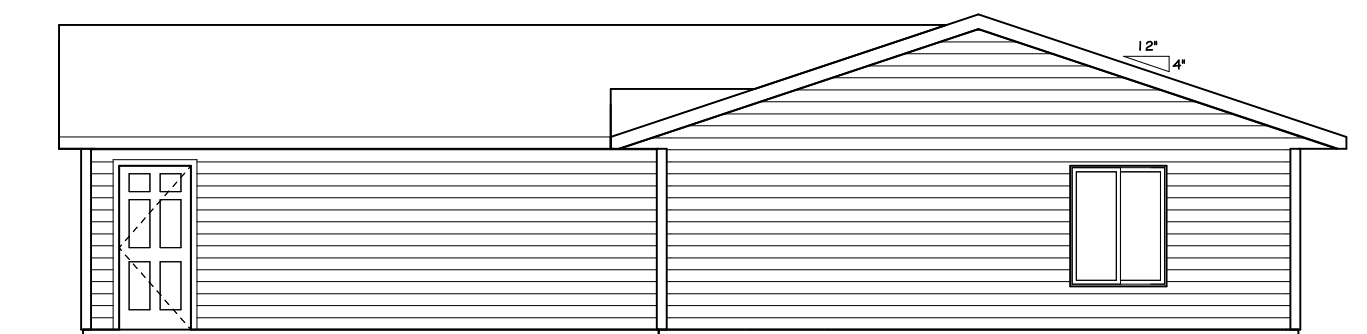

2 RIGHT
A1 1/4" = 1'-0"

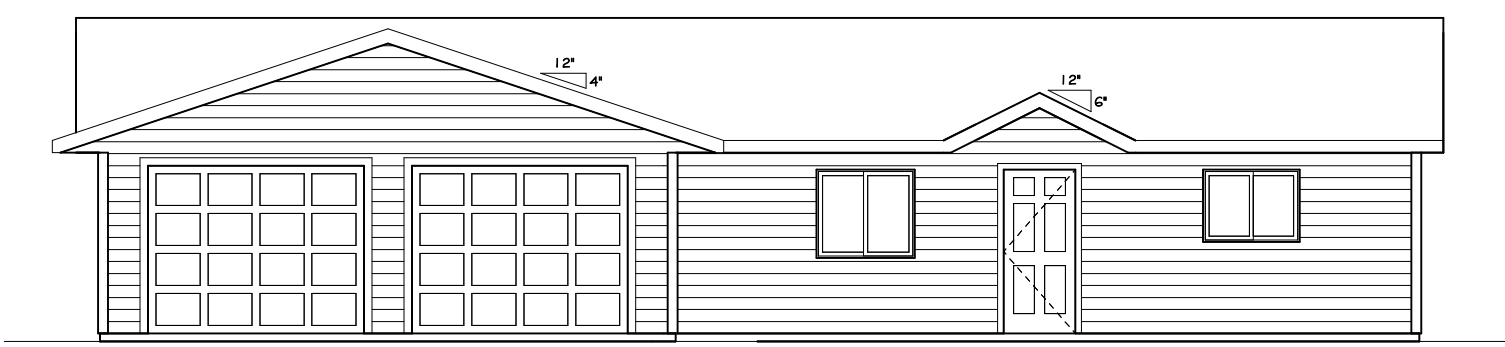

4 FRONT
A1 1/4" = 1'-0"

HILLTOP LUMBER
We help plan, supply and deliver dreams.
ALEXANDRIA - GLENWOOD - PARKERS PRAIRIE - OTTERTAIL

1405 NORTH NOKOMIS NE
ALEXANDRIA, MN 56308
OFFICE: 320-763-9663
WWW.HILLTOPLBR.COM

LEGAL DISCLAIMER
The plans furnished herewith were prepared upon request by draftsmen who are not registered architects or professional engineers and are for INFORMATIONAL PURPOSES ONLY. Hilltop Lumber, Inc. of Glenwood makes NO WARRANTIES WHATSOEVER, EITHER EXPRESSED OR IMPLIED as to merchantability or fitness for a particular purpose and places any user(s) on notice that reliance upon said plans shall be at the sole risk of the user(s). The selection of correct structural materials and the application of architectural principals is a precise art, the responsibility for which rests with the builder, the owner, or the user of these plans.

© COPYRIGHT 2021
These drawings are the property of Hilltop Lumber, Inc. of Glenwood and are protected by federal copyright law. Any unauthorized use or reproduction of these plans is prohibited by law.

HABITAT FOR HUMANITY
276 GREENVILLE LN, MILTONA

Designer: NATHAN
Date: 8-9-2023
Status: FINAL
Number: 21-364

ELEVATIONS

A1

PROPERTY LINE
126.00'

- THE STREET SHALL BE SWEEPED CLEAN BEFORE THE END OF EACH DAY OF ACTIVE CONSTRUCTION, WHEN SEDIMENT IS TRACKED ONTO THE STREET.
- AREAS WITH SLOPES GREATER THAN 3:1 AND AREAS ADJACENT TO WETLANDS/WATERBODIES DISTURBED DURING CONSTRUCTION SHALL BE PROTECTED WITH TEMPORARY VEGETATION, MULCHING OR OTHER MEANS AS SOON AS PRACTICAL.
- ALL EXPOSED SOIL AREAS SHALL BE STABILIZED AS SOON AS PRACTICAL.
- UNWORKED SOILS THAT REMAIN EXPOSED AND NOT IN USE FOR LONGER THAN 14 DAYS SHALL BE SEEDED WITH TEMPORARY SEED (GRASS, OATS OR WHEAT) IN ADDITION TO BEING STABILIZED.
- NO CONCRETE WASHOUT SHALL OCCUR ON SITE UNLESS IT IS DONE WITH AN APPROVED MPCA DEVICE OR STANDARD.
- STOCKPILES SHALL BE STABILIZED AND SURROUNDED WITH ADEQUATE PERIMETER CONTROL TO PREVENT SEDIMENTATION.
- INLET PROTECTION FOR ALL STORM SEWER INLETS DOWNSTREAM AND WITHIN ONE BLOCK OF SITE SHALL BE INSTALLED AND MAINTAINED.
- SITE SHALL BE KEPT CLEAN AT ALL TIMES AND REFUSE PROPERLY CONTROLLED.
- TEMPORARY PUMPING SHALL NOT BE PERMITTED WITHOUT USE OF AN APPROVED MPCA DEVICE OR STANDARD.
- SOIL COMPACTION SHALL BE MINIMIZED.
- ALL TEMPORARY SYNTHETIC BMPs TO BE REMOVED UPON PERMANENT STABILIZATION.

FINISHED DRAINAGE

NOTE:
VERIFY LOCATION OF CITY
SEWER AND WATER HOOK-UP

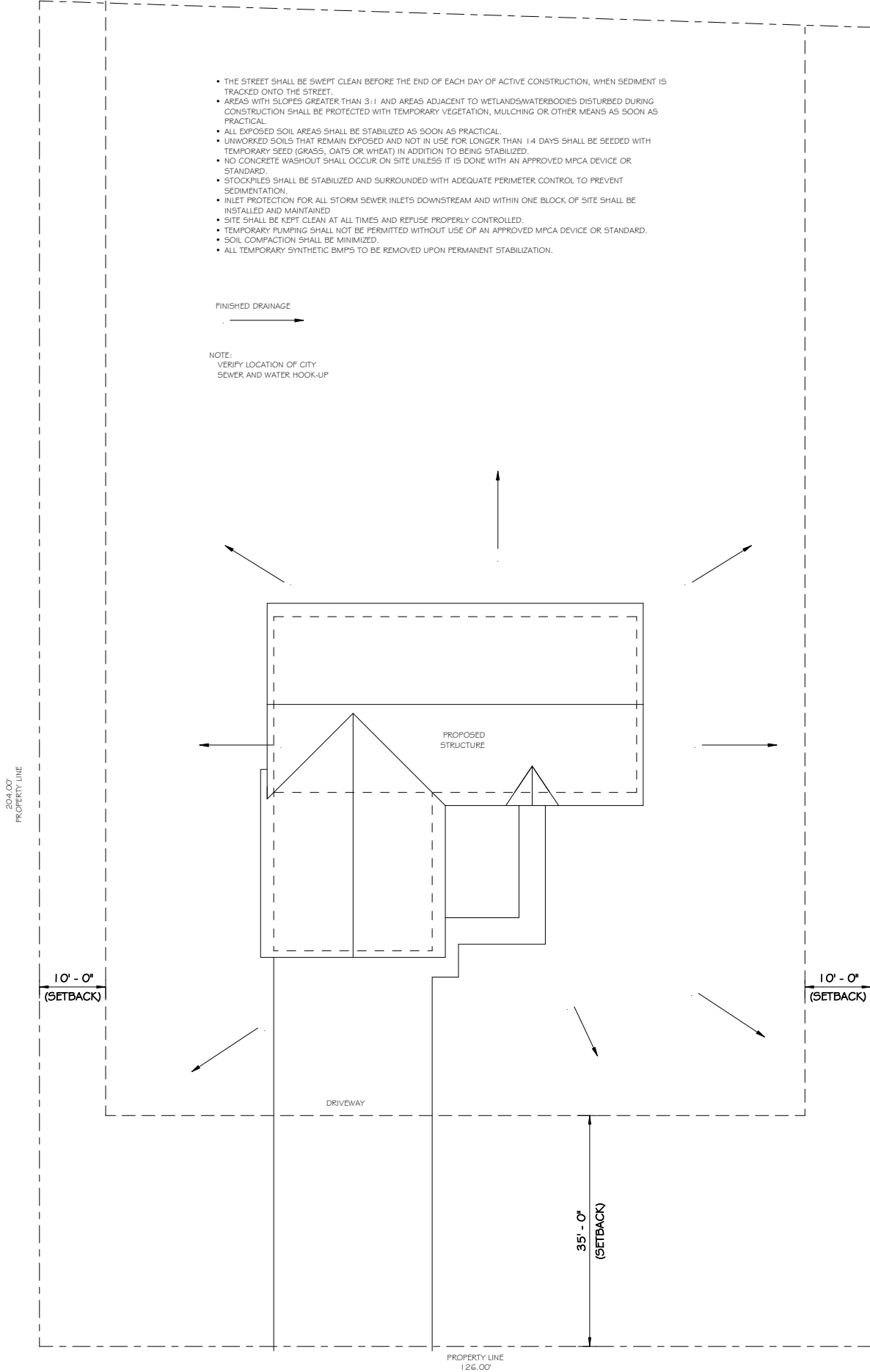

2 SITE PLAN
3/32" = 1'-0"

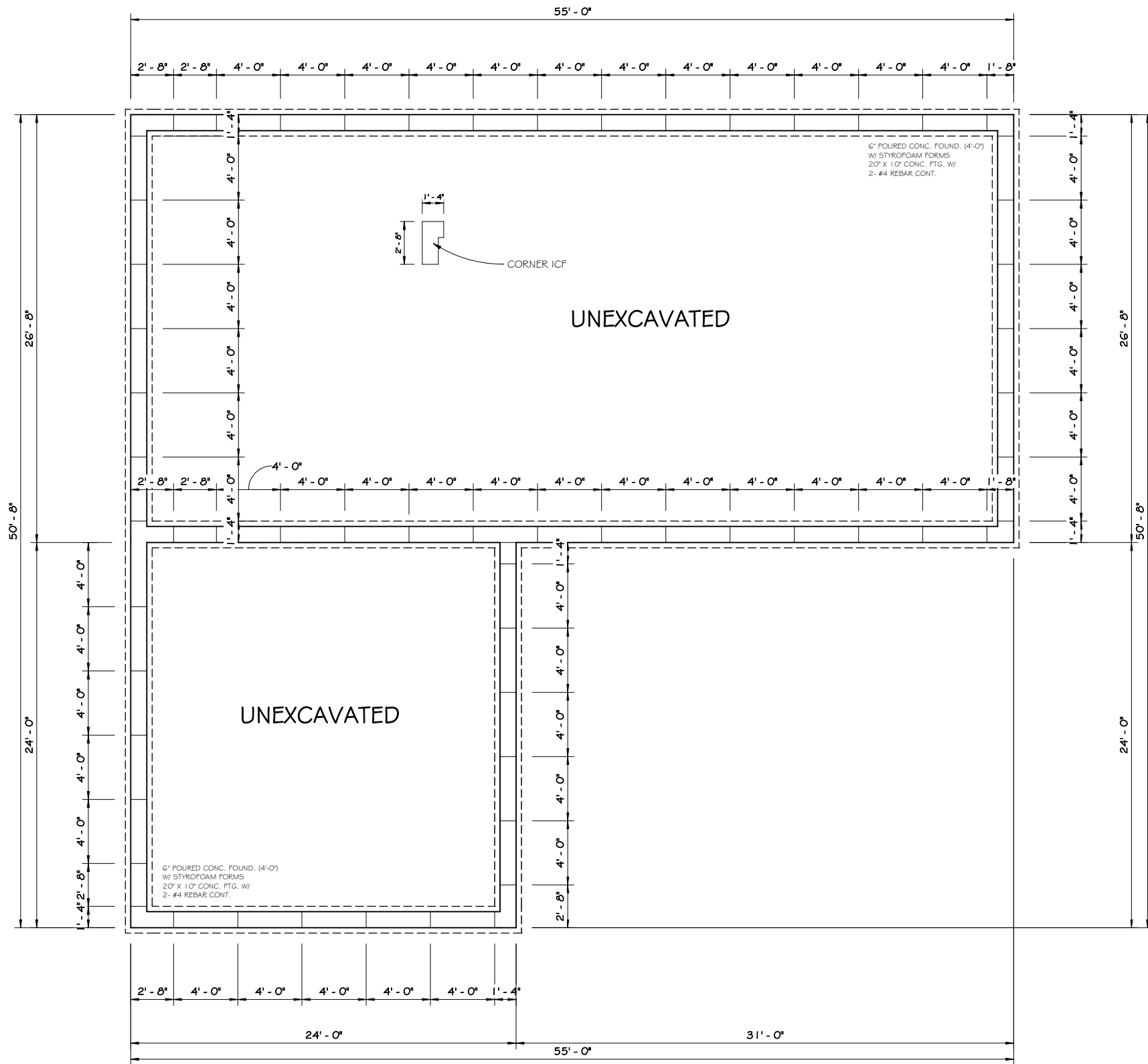

1 BASEMENT PLAN
1/4" = 1'-0"



1405 NORTH NOKOMIS NE
ALEXANDRIA, MN 56308
OFFICE: 320-763-9663
WWW.HILLTOPLBR.COM

LEGAL DISCLAIMER

The plans furnished hereunder were prepared upon request by draftsmen who are not registered architects or professional engineers and are for INFORMATIONAL PURPOSES ONLY. Hilltop Lumber, Inc. of Glenwood makes NO WARRANTIES WHATSOEVER, EITHER EXPRESSED OR IMPLIED as to merchantability or fitness for a particular purpose and places any inserts on notice that reliance upon said plans shall be at the sole risk of the user(s). The selection of correct structural materials and the application of architectural principals is a precise art, the responsibility for which rests with the builder, the owner, or the user of these plans.

© COPYRIGHT 2021

These drawings are the property of Hilltop Lumber, Inc. of Glenwood and are protected by federal copyright law. Any unauthorized use or reproduction of these plans is prohibited by law.

HABITAT FOR HUMANITY
276 GREENVILLE LN, MILTONA

Designer: NATHAN
Date: 8-9-2023
Status: FINAL
Number: 21-364

FOUNDATION

A2

PASSIVE SUB-SLAB DEPRESSURIZATION RADON CONTROL SYSTEM FOR NEW CONSTRUCTION

- NOTES:
1. ALL CONCRETE SLABS THAT COME IN CONTACT WITH THE GROUND SHALL BE LAD OVER A GAS PERMEABLE MATERIAL MADE UP OF EITHER A MINIMUM 4" THICK UNIFORM LAYER OF CLEAN AGGREGATE, OR A MINIMUM 4" THICK UNIFORM LAYER OF SAND, OVERLAIN BY A LAYER OF STRIPS OF MANUFACTURED MATTING DESIGNED TO ALLOW THE LATERAL FLOW OF SOIL GASES.
 2. ALL CONCRETE FLOOR SLABS SHALL BE DESIGNED AND CONSTRUCTED IN ACCORDANCE WITH LOCAL BUILDING CODES. ADDITIONAL REFS: AMERICAN CONCRETE INSTITUTE PUBLICATIONS, "ACI 202.1R" & "ACI 332R", OR THE POST TENSIONING INSTITUTE MANUAL, "DESIGN AND CONSTRUCTION OF POST-TENSIONED SLABS ON GROUND".
 3. ALL OPENINGS, GAPS AND JOINTS IN FLOOR AND WALL ASSEMBLIES IN CONTACT SOIL OR GAPS AROUND PIPES, TOILETS, BATHTUBS OR DRAINS PENETRATING THESE ASSEMBLIES SHALL BE FILLED OR CLOSED WITH MATERIALS THAT PROVIDED A PERMANENT AIR-TIGHT SEAL. SEAL LARGER OPENINGS WITH NON-SHRINK MORTAR, GROUTS OR EXPANDING FORM MATERIALS AND SMALLER GAPS WITH AN ELASTOMERIC JOINT SEALANT, AS DEFINED IN ASTM C920-97.
 4. VENT PIPES SHALL BE INSTALLED SO THAT AND RAINWATER OR CONDENSATION DRAINS DOWNWARD INTO THE GROUND BENEATH THE SLAB OR SOIL-GAS-RETARDER MEMBRANE.
 5. CIRCUITS SHOULD BE A MINIMUM 15 AMP, 115 VOLT.

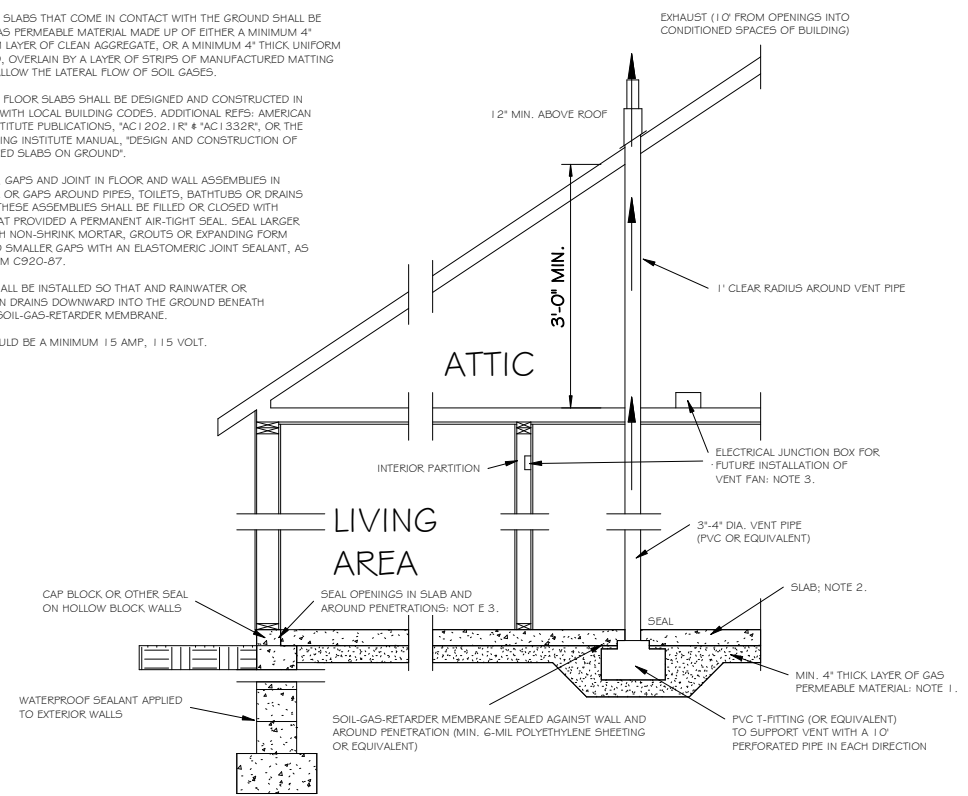

2 - Radon Section
1/2" = 1'-0"

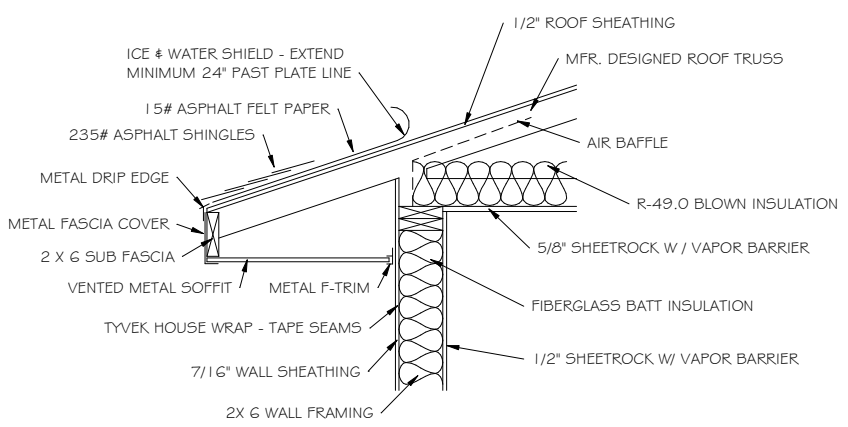

3 - Roof Details
1" = 1'-0"

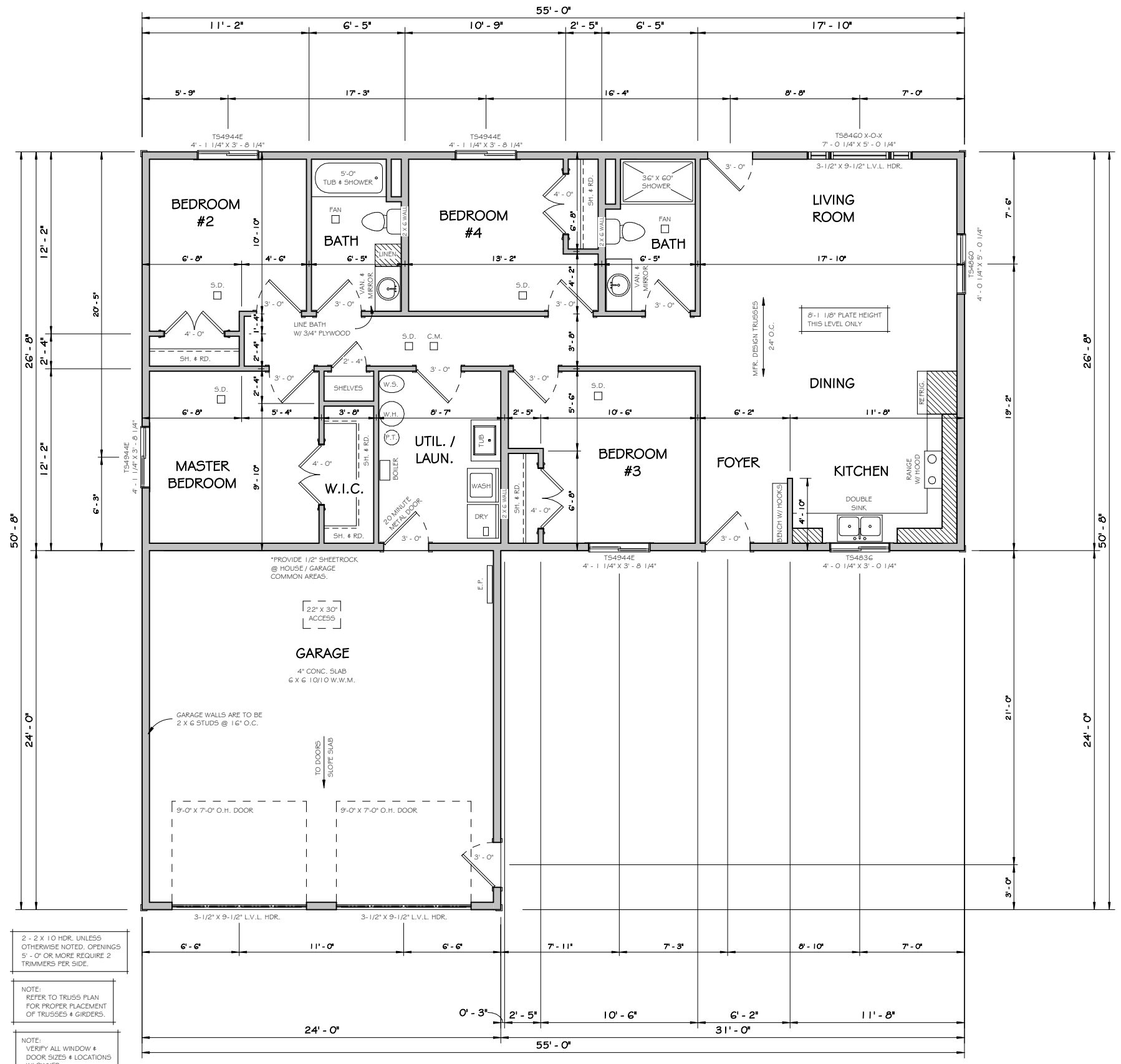

- 2 - 2 X 10 HDR. UNLESS OTHERWISE NOTED, OPENINGS 5' - 0" OR MORE REQUIRE 2 TRIMMERS PER SIDE.
- NOTE: REFER TO TRUSS PLAN FOR PROPER PLACEMENT OF TRUSSES & GIRDERS.
- NOTE: VERIFY ALL WINDOW & DOOR SIZES & LOCATIONS W/ OWNER.

1 MAIN LEVEL
1/4" = 1'-0"



1405 NORTH NOKOMIS NE
ALEXANDRIA, MN 56308
OFFICE: 320-763-9663
WWW.HILLTOPLBR.COM

LEGAL DISCLAIMER
The plans furnished herewith were prepared upon request by draftsmen who are not registered architects or professional engineers and are for INFORMATIONAL PURPOSES ONLY. Hilltop Lumber, Inc. of Glenwood makes NO WARRANTIES WHATSOEVER, EITHER EXPRESSED OR IMPLIED as to merchantability or fitness for a particular purpose and places any user(s) on notice that reliance upon said plans shall be at the sole risk of the user(s). The selection of correct structural materials and the application of architectural principles is a precise art, the responsibility for which rests with the builder, the owner, or the user of these plans.

© COPYRIGHT 2021
These drawings are the property of Hilltop Lumber, Inc. of Glenwood and are protected by federal copyright law. Any unauthorized use or reproduction of these plans is prohibited by law.

HABITAT FOR HUMANITY
276 GREENVILLE LN, MILTONA

Designer: NATHAN
Date: 8-9-2023
Status: FINAL
Number: 21-364

MAIN LEVEL
1,467 SQ. FT.

A3

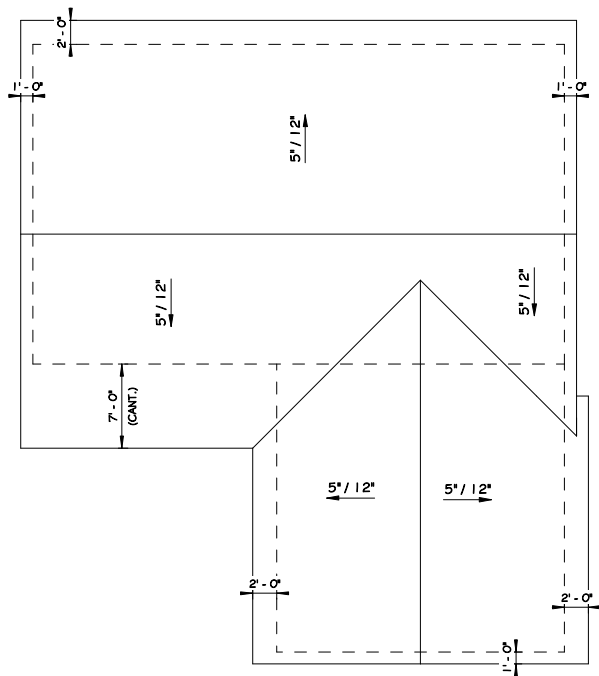

5 ROOF PLAN
AI 1/8" = 1'-0"

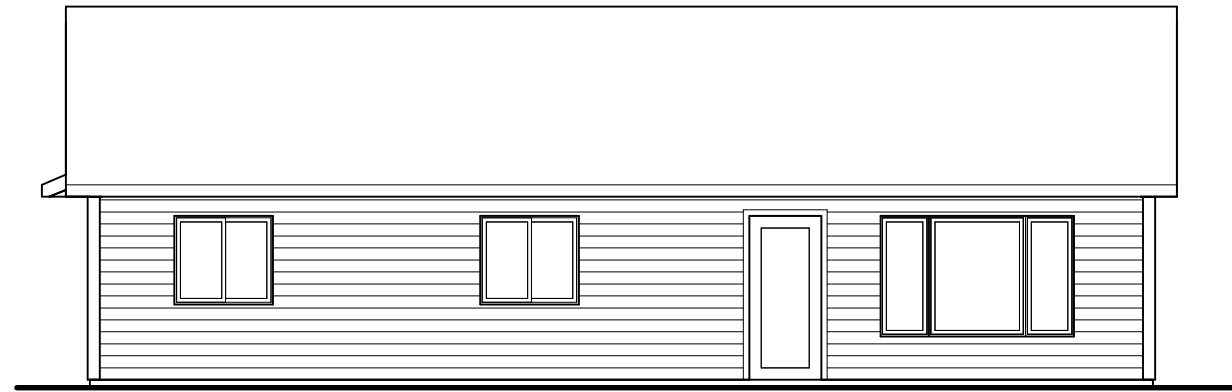

1 REAR
AI 1/4" = 1'-0"

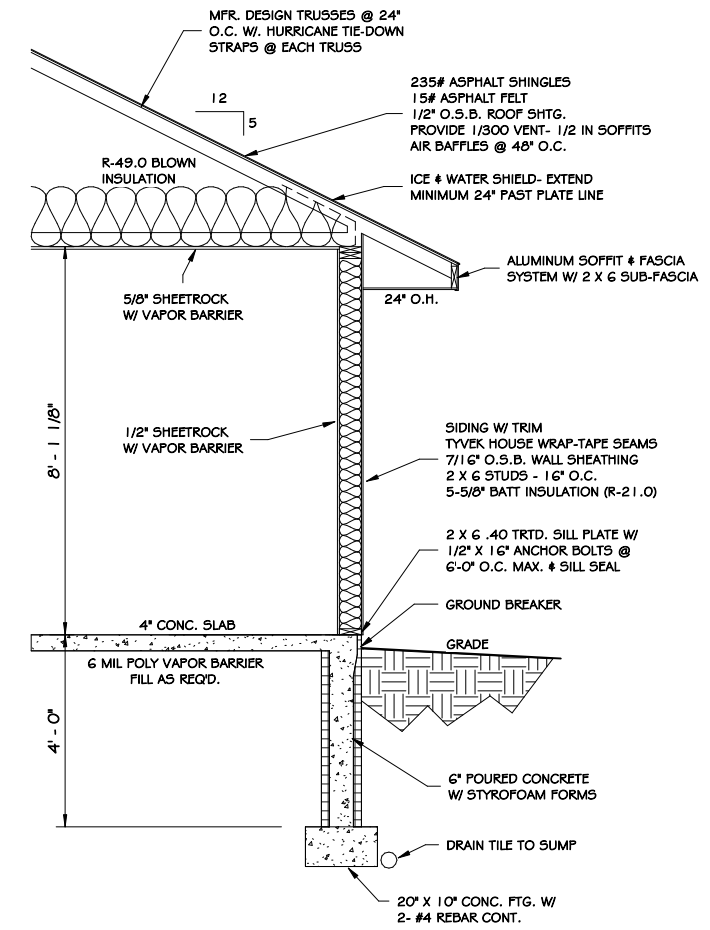

6 - Wall Section
AI 1/2" = 1'-0"

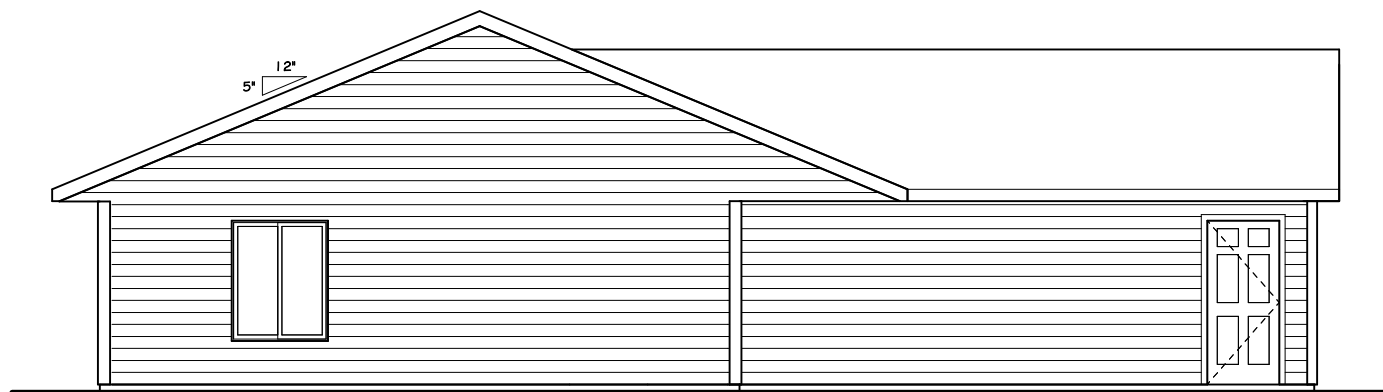

2 LEFT
AI 1/4" = 1'-0"



3 RIGHT
AI 1/4" = 1'-0"

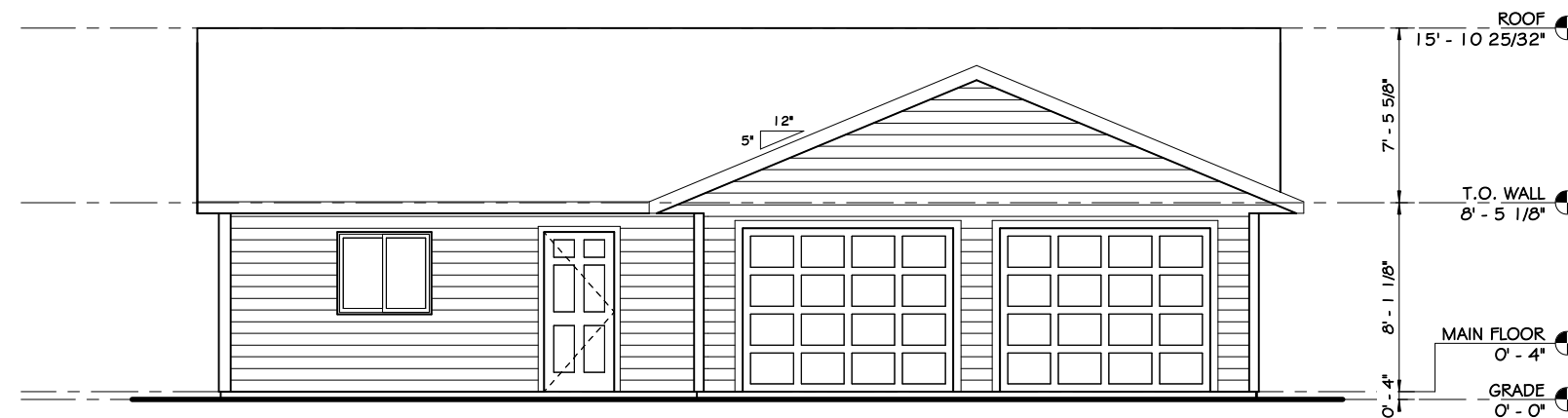

4 FRONT
AI 1/4" = 1'-0"

HILLTOP LUMBER
We help plan, supply and deliver dreams.
ALEXANDRIA - GLENWOOD - PARKERS PRAIRIE - OTTERTAIL

1405 NORTH NOKOMIS NE
ALEXANDRIA, MN 56308
OFFICE: 320-763-9663
WWW.HILLTOPLBR.COM

LEGAL DISCLAIMER
The plans furnished hereunder were prepared upon request by draftsmen who are not registered architects or professional engineers and are for INFORMATIONAL PURPOSES ONLY. Hilltop Lumber, Inc. of Glenwood makes NO WARRANTIES WHATSOEVER, EITHER EXPRESSED OR IMPLIED as to merchantability or fitness for a particular purpose and places any inserts on notice that reliance upon said plans shall be at the sole risk of the user(s). The selection of correct structural materials and the application of architectural principals is a precise art, the responsibility for which rests with the builder, the owner, or the user of these plans.

© COPYRIGHT 2021
These drawings are the property of Hilltop Lumber, Inc. of Glenwood and are protected by federal copyright law. Any unauthorized use or reproduction of these plans is prohibited by law.

HABITAT FOR HUMANITY
ABBYGAIL DRIVE

Designer: NATHAN
Date: 11-20-2023
Status: FINAL
Number: 23-370

ELEVATIONS

AI

PASSIVE SUB-SLAB DEPRESSURIZATION RADON CONTROL SYSTEM FOR NEW CONSTRUCTION

- NOTES:
1. ALL CONCRETE SLABS THAT COME IN CONTACT WITH THE GROUND SHALL BE LAID OVER A GAS PERMEABLE MATERIAL MADE UP OF EITHER A MINIMUM 4" THICK UNIFORM LAYER OF CLEAN AGGREGATE, OR A MINIMUM 4" THICK UNIFORM LAYER OF SAND, OVERLAIN BY A LAYER OF STRIPS OF MANUFACTURED MATTING DESIGNED TO ALLOW THE LATERAL FLOW OF SOIL GASES.
 2. ALL CONCRETE FLOOR SLABS SHALL BE DESIGNED AND CONSTRUCTED IN ACCORDANCE WITH LOCAL BUILDING CODES, ADDITIONAL REFS: AMERICAN CONCRETE INSTITUTE PUBLICATIONS, "ACI 202.1R" & "ACI 332R", OR THE POST-TENSIONING INSTITUTE MANUAL, "DESIGN AND CONSTRUCTION OF POST-TENSIONED SLABS ON GROUND".
 3. ALL OPENINGS, GAPS AND JOINT IN FLOOR AND WALL ASSEMBLIES IN CONTACT SOIL OR GAPS AROUND PIPES, TOILETS, BATHTUBS OR DRAINS PENETRATING THESE ASSEMBLIES SHALL BE FILLED OR CLOSED WITH MATERIALS THAT PROVIDED A PERMANENT AIR-TIGHT SEAL. SEAL LARGER OPENINGS WITH NON-SHRINK MORTAR, GROUTS OR EXPANDING FORM MATERIALS AND SMALLER GAPS WITH AN ELASTOMERIC JOINT SEALANT, AS DEFINED IN ASTM C920-87.
 4. VENT PIPES SHALL BE INSTALLED SO THAT AND RAINWATER OR CONDENSATION DRAINS DOWNWARD INTO THE GROUND BENEATH THE SLAB OR SOIL-GAS-RETARDER MEMBRANE.
 5. CIRCUITS SHOULD BE A MINIMUM 15 AMP, 115 VOLT.

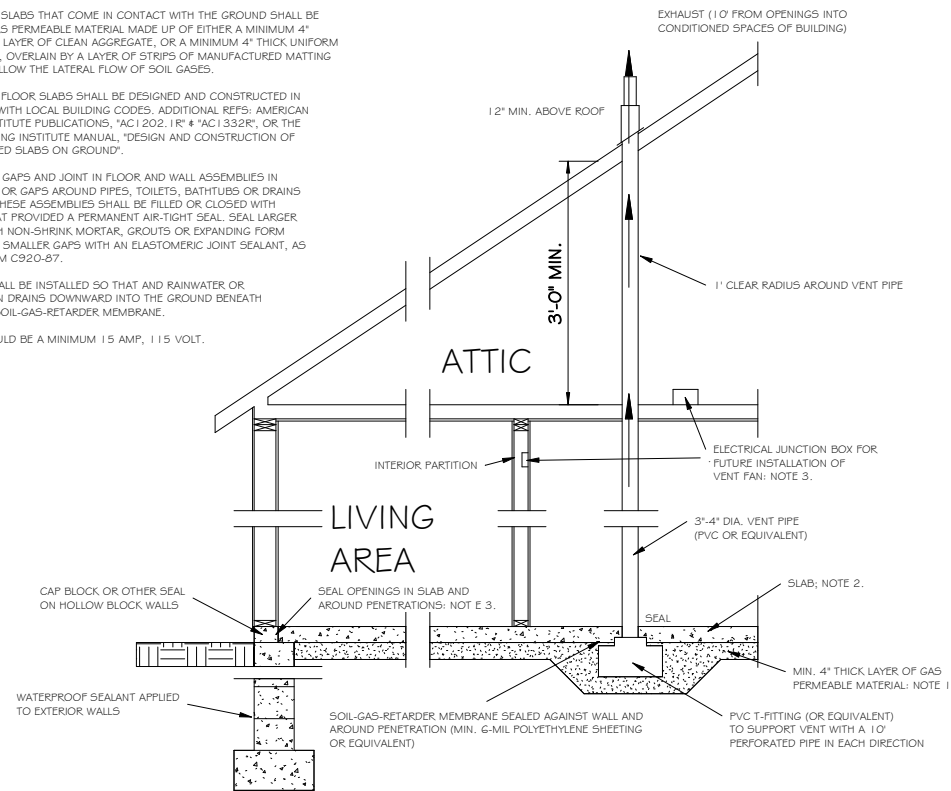

3 - Radon Section
1/2" = 1'-0"

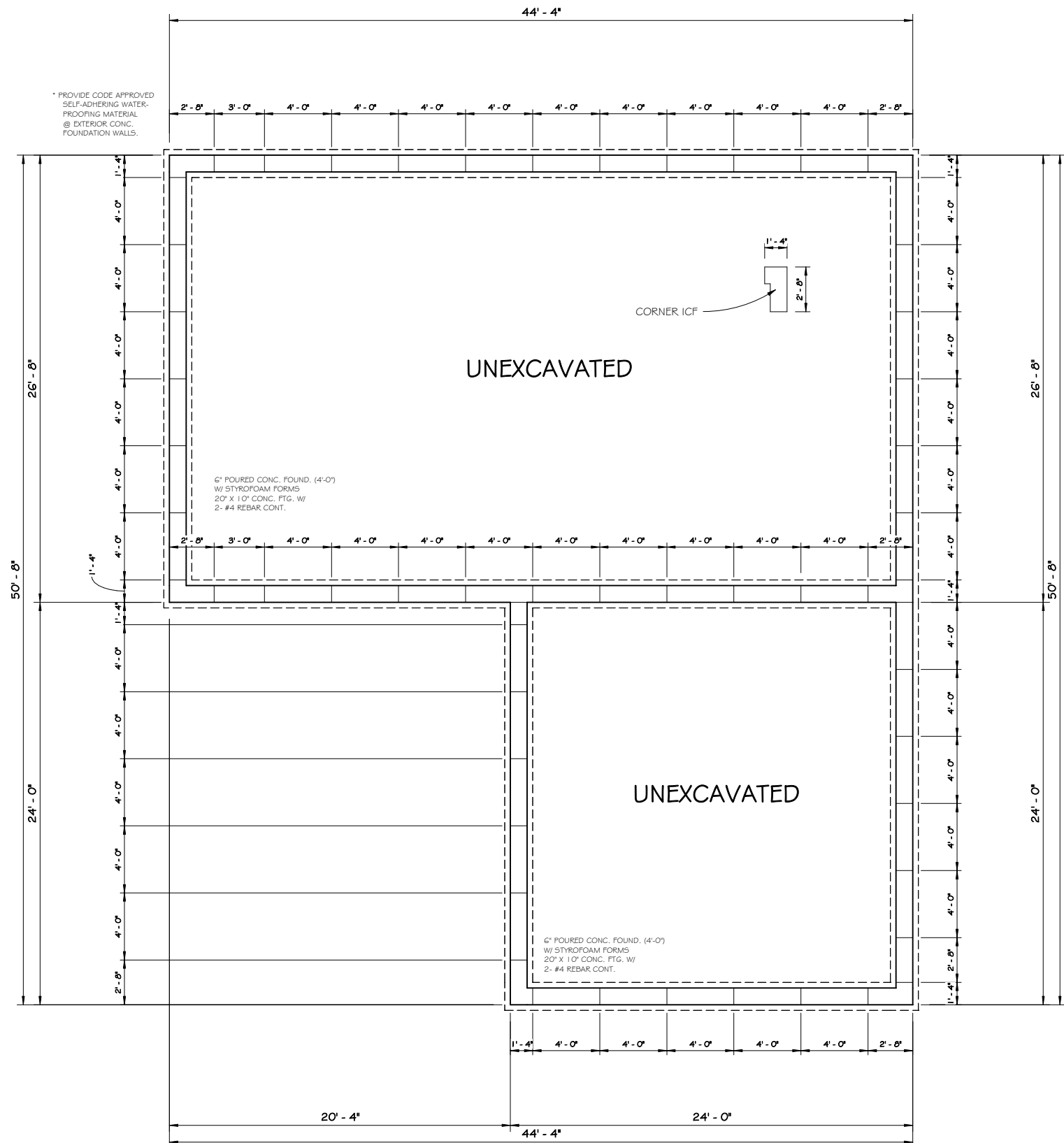

1 BASEMENT PLAN
1/4" = 1'-0"

LEGAL DISCLAIMER

The plans furnished herewith were prepared upon request by draftsmen who are not registered architects or professional engineers and are for INFORMATIONAL PURPOSES ONLY. Hilltop Lumber, Inc. of Glenwood makes NO WARRANTIES WHATSOEVER, EITHER EXPRESSED OR IMPLIED as to merchantability or fitness for a particular purpose and places any inserts on notice that reliance upon said plans shall be at the sole risk of the user(s). The selection of correct structural materials and the application of architectural principals is a precise art, the responsibility for which rests with the builder, the owner, or the user of these plans.

© COPYRIGHT 2021

These drawings are the property of Hilltop Lumber, Inc. of Glenwood and are protected by federal copyright law. Any unauthorized use or reproduction of these plans is prohibited by law.

HABITAT FOR HUMANITY
ABBYGAIL DRIVE

Designer: NATHAN
Date: 11-20-2023
Status: FINAL
Number: 23-370

FOUNDATION

A2

- THE STREET SHALL BE SWEEPED CLEAN BEFORE THE END OF EACH DAY OF ACTIVE CONSTRUCTION, WHEN SEDIMENT IS TRACKED ONTO THE STREET.
- AREAS WITH SLOPES GREATER THAN 3:1 AND AREAS ADJACENT TO WETLANDS/WATERBODIES DISTURBED DURING CONSTRUCTION SHALL BE PROTECTED WITH TEMPORARY VEGETATION, MULCHING OR OTHER MEANS AS SOON AS PRACTICAL.
- ALL EXPOSED SOIL AREAS SHALL BE STABILIZED AS SOON AS PRACTICAL.
- UNWORKED SOILS THAT REMAIN EXPOSED AND NOT IN USE FOR LONGER THAN 14 DAYS SHALL BE SEEDED WITH TEMPORARY SEED (GRASS, OATS OR WHEAT) IN ADDITION TO BEING STABILIZED.
- NO CONCRETE WASHOUT SHALL OCCUR ON SITE UNLESS IT IS DONE WITH AN APPROVED MPCA DEVICE OR STANDARD.
- STOCKPILES SHALL BE STABILIZED AND SURROUNDED WITH ADEQUATE PERIMETER CONTROL TO PREVENT SEDIMENTATION.
- INLET PROTECTION FOR ALL STORM SEWER INLETS DOWNSTREAM AND WITHIN ONE BLOCK OF SITE SHALL BE INSTALLED AND MAINTAINED.
- SITE SHALL BE KEPT CLEAN AT ALL TIMES AND REFUSE PROPERLY CONTROLLED.
- TEMPORARY PUMPING SHALL NOT BE PERMITTED WITHOUT USE OF AN APPROVED MPCA DEVICE OR STANDARD.
- SOIL COMPACTION SHALL BE MINIMIZED.
- ALL TEMPORARY SYNTHETIC BMPs TO BE REMOVED UPON PERMANENT STABILIZATION.

NOTE:
VERIFY LOCATION OF CITY
SEWER AND WATER HOOK-UP

FINISHED DRAINAGE

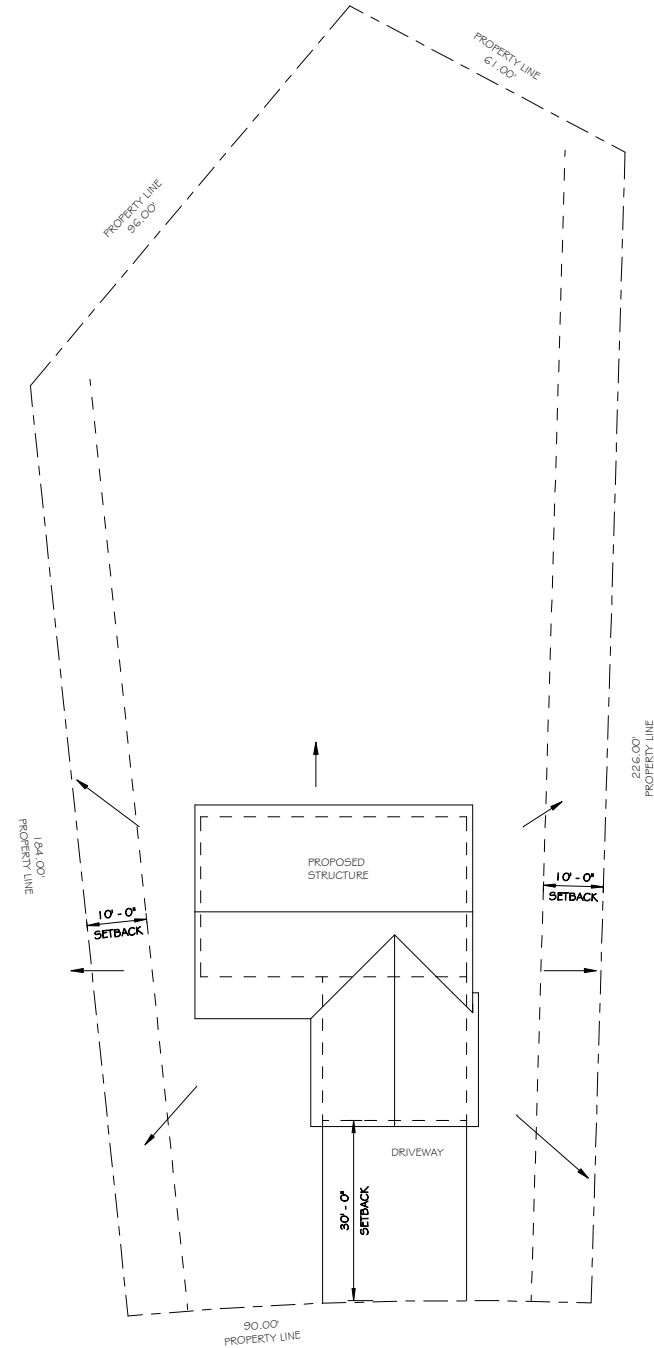

2 SITE PLAN
1/16" = 1'-0"

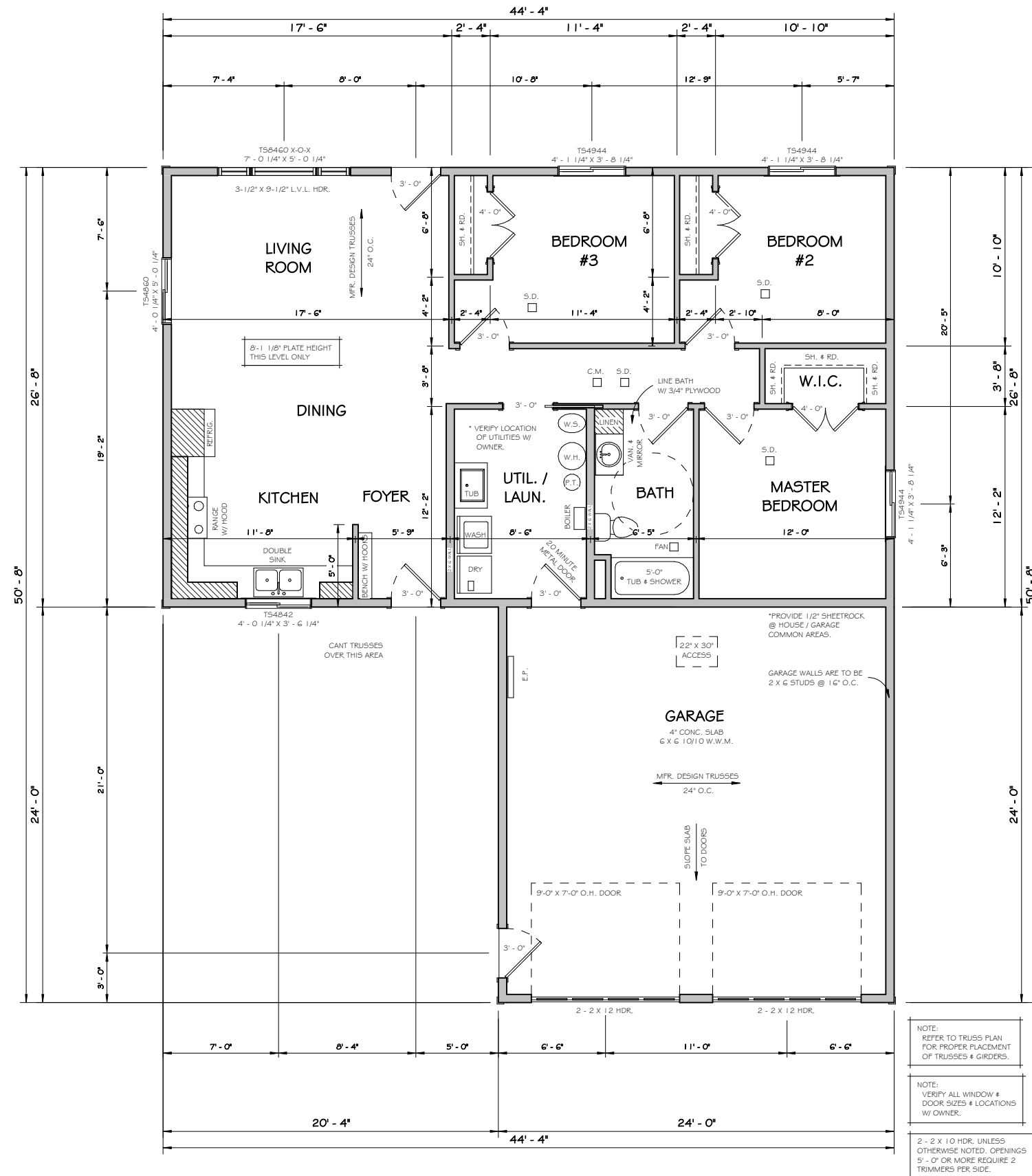

1 MAIN LEVEL
1/4" = 1'-0"

1405 NORTH NOKOMIS NE
ALEXANDRIA, MN 56308
OFFICE: 320-763-9663
WWW.HILLTOPLBR.COM

LEGAL DISCLAIMER

The plans furnished herewith were prepared upon request by draftsmen who are not registered architects or professional engineers and are for INFORMATIONAL PURPOSES ONLY. Hilltop Lumber, Inc. of Glenwood makes NO WARRANTIES WHATSOEVER, EITHER EXPRESSED OR IMPLIED as to merchantability or fitness for a particular purpose and places any useful notice that reliance upon said plans shall be at the sole risk of the user(s). The selection of correct structural materials and the application of architectural principals is a precise art, the responsibility for which rests with the builder, the owner, or the user of these plans.

© COPYRIGHT 2021

These drawings are the property of Hilltop Lumber, Inc. of Glenwood and are protected by federal copyright law. Any unauthorized use or reproduction of these plans is prohibited by law.

HABITAT FOR HUMANITY
ABBYGAIL DRIVE

Designer: NATHAN
Date: 11-20-2023
Status: FINAL
Number: 23-370

MAIN LEVEL
1,183 SQ. FT.

A3

Request for Taxpayer Identification Number and Certification

Give Form to the requester. Do not send to the IRS.

► Go to www.irs.gov/FormW9 for instructions and the latest information.

1 Name (as shown on your income tax return). Name is required on this line; do not leave this line blank.

2 Business name/disregarded entity name, if different from above

3 Check appropriate box for federal tax classification of the person whose name is entered on line 1. Check only **one** of the following seven boxes.

Individual/sole proprietor or single-member LLC

Limited liability company. Enter the tax classification (C=C corporation, S=S corporation, P=Partnership) ► _____

Note: Check the appropriate box in the line above for the tax classification of the single-member owner. Do not check LLC if the LLC is classified as a single-member LLC that is disregarded from the owner unless the owner of the LLC is another LLC that is **not** disregarded from the owner for U.S. federal tax purposes. Otherwise, a single-member LLC that is disregarded from the owner should check the appropriate box for the tax classification of its owner.

Other (see instructions) ► _____

C Corporation

S Corporation

Partnership

Trust/estate

4 Exemptions (codes apply only to certain entities, not individuals; see instructions on page 3):

Exempt payee code (if any) _____

Exemption from FATCA reporting code (if any) _____

(Applies to accounts maintained outside the U.S.)

5 Address (number, street, and apt. or suite no.) See instructions.

6 City, state, and ZIP code

7 List account number(s) here (optional)

Requester's name and address (optional)

Part I Taxpayer Identification Number (TIN)

Enter your TIN in the appropriate box. The TIN provided must match the name given on line 1 to avoid backup withholding. For individuals, this is generally your social security number (SSN). However, for a resident alien, sole proprietor, or disregarded entity, see the instructions for Part I, later. For other entities, it is your employer identification number (EIN). If you do not have a number, see *How to get a TIN*, later.

Note: If the account is in more than one name, see the instructions for line 1. Also see *What Name and Number To Give the Requester* for guidelines on whose number to enter.

Social security number								
				-			-	
or								
Employer identification number								

Part II Certification

Under penalties of perjury, I certify that:

- The number shown on this form is my correct taxpayer identification number (or I am waiting for a number to be issued to me); and
- I am not subject to backup withholding because: (a) I am exempt from backup withholding, or (b) I have not been notified by the Internal Revenue Service (IRS) that I am subject to backup withholding as a result of a failure to report all interest or dividends, or (c) the IRS has notified me that I am no longer subject to backup withholding; and
- I am a U.S. citizen or other U.S. person (defined below); and
- The FATCA code(s) entered on this form (if any) indicating that I am exempt from FATCA reporting is correct.

Certification instructions. You must cross out item 2 above if you have been notified by the IRS that you are currently subject to backup withholding because you have failed to report all interest and dividends on your tax return. For real estate transactions, item 2 does not apply. For mortgage interest paid, acquisition or abandonment of secured property, cancellation of debt, contributions to an individual retirement arrangement (IRA), and generally, payments other than interest and dividends, you are not required to sign the certification, but you must provide your correct TIN. See the instructions for Part II, later.

Sign Here	Signature of U.S. person ►	Date ►

General Instructions

Section references are to the Internal Revenue Code unless otherwise noted.

Future developments. For the latest information about developments related to Form W-9 and its instructions, such as legislation enacted after they were published, go to www.irs.gov/FormW9.

Purpose of Form

An individual or entity (Form W-9 requester) who is required to file an information return with the IRS must obtain your correct taxpayer identification number (TIN) which may be your social security number (SSN), individual taxpayer identification number (ITIN), adoption taxpayer identification number (ATIN), or employer identification number (EIN), to report on an information return the amount paid to you, or other amount reportable on an information return. Examples of information returns include, but are not limited to, the following.

- Form 1099-INT (interest earned or paid)

- Form 1099-DIV (dividends, including those from stocks or mutual funds)
- Form 1099-MISC (various types of income, prizes, awards, or gross proceeds)
- Form 1099-B (stock or mutual fund sales and certain other transactions by brokers)
- Form 1099-S (proceeds from real estate transactions)
- Form 1099-K (merchant card and third party network transactions)
- Form 1098 (home mortgage interest), 1098-E (student loan interest), 1098-T (tuition)
- Form 1099-C (canceled debt)
- Form 1099-A (acquisition or abandonment of secured property)

Use Form W-9 only if you are a U.S. person (including a resident alien), to provide your correct TIN.

If you do not return Form W-9 to the requester with a TIN, you might be subject to backup withholding. See What is backup withholding, later.

**Determination of independent contractor status
for workers' compensation insurance coverage**

Note to subcontractor: Please complete this form and return it to the person or business for which you are performing the contracted work. Please also attach copies of your insurance certificate and/or your Independent Contractor Registration, if your state requires that you be registered.

Subcontractor business name _____

Operates as: sole proprietor _____ partnership _____ corporation _____

Dates work is to be performed _____

Yes No

- Do you plan to use or hire employees, casual labor or subcontractors during the dates for which work will be done?
- Do you maintain a separate business with your own office, equipment and materials?
- Will you be working for specific amounts of money and controlling how the work is done?
- Do you have, or have you applied for, a Federal Employer Identification Number?
Enter your FEIN _____
- Will you incur the main expenses related to the work performed?
- Are you responsible for the satisfactory completion of the work you have contracted to perform and are you liable for failure to complete it?
- Will you receive compensation for work performed under the contract on a commission or per-job basis and not on any other basis?
- Will you realize a profit or loss under the contract?
- Do you have recurring business liabilities or obligations?
- Does the success of your business depend on business receipts being sufficient to cover expenses?

Signature _____ Date _____

Name of SFM policyholder HFH of Douglas County Minnesota Inc

Policy No. 74015.206

Instructions to SFM policyholder

When you need to use this form

You must always have your subcontractor furnish you with a certificate showing workers' compensation coverage in force at the time of the subcontracted job. This is essential when the subcontractor uses employees.

However, an individual doing the subcontracted job by himself may not need to carry workers' compensation. If your subcontractor is working by himself and does not provide you with a Certificate of Workers' Compensation Insurance because he claims to be an independent contractor, then you must have the subcontractor fill out the form on the other side.

- 1) Make photocopies of this form. Be sure to copy both sides.**
- 2) At the top of this page, fill in your company's name and policy number.**
- 3) Have the subcontractor complete the form on the other side and return it to you promptly. Keep it with your records and make it available to your SFM auditor.**

Your SFM auditor will want copies of (1) this completed form, (2) the subcontractor's Independent Contractor Registration, and (3) the subcontractor's Certificate of Insurance for General Liability covering the dates the work was performed. This will enable SFM to determine whether the subcontractor meets the legal criteria for "independent contractor" for purposes of calculating your workers' compensation premium.

SECTION 00 41 23 - PROPOSAL BID FORM

SUBMIT PROPOSAL TO: HFH of Douglas County, Minnesota, Inc.
1211 N Nokomis NE, Alexandria, MN 56308

FOR: **Construction of Habitat for Humanity Homes**

SUBMITTED BY: _____

FOR BID DIVISION(S): _____



CONTRACT DOCUMENTS

We have carefully read and fully understand the Contract Documents, including the Instructions to Bidders (Section 00 21 13), General Requirements, Proposal Section, Technical Specifications, and floor plans covering the work required in our proposal and the specifications.

ADDENDA

We acknowledge the receipt of Addenda _____, _____, and _____
Dated _____, _____, and _____

CONSTRUCTION MANAGEMENT

We understand the Construction Manager's function as described and referred to throughout the Contract Documents. We realize that each Bid Division Contractor is in fact a Prime Contractor and not a Sub-contractor working through a General Contractor.

SCHEDULE

We have reviewed the Milestone Schedule and hereby endorse the milestone dates with regard to the work of the bid divisions we have bid.



EXCEPTIONS AND/OR SUBSTITUTIONS

We have submitted our proposal complete as specified and shown on the drawings without exceptions or substitutions.

AGREEMENT

This proposal and attached pricing form, if accepted by Habitat within thirty (30) days of the date designated for receiving proposals, will be the basis for a Contract directly with the Owner. The undersigned hereby agrees to accept a Contract for the work covered by the proposal, under the terms and conditions of the Contract Documents.

We acknowledge the fact that the Owner has the right to accept or reject any and all proposals with or without cause or reason.

NAME OF BIDDER: _____

ADDRESS: _____

BY: _____ **(Signature)**

_____ **(Type or Print)**

TITLE: _____

DATE: _____

PHONE: _____

FAX: _____

EMAIL: _____

ENCLOSURES: _____

OTHER: _____

Habitat Acceptance of Proposal

Signature _____ Title _____ Date _____

For Office Use Only:

W-9, dated _____

ICEC (if applicable) _____

Indend Cont expires _____

W Comp, expires _____

Gen'l Liab, expires _____

Approved date _____

Approved initials _____

PROPOSAL BID FORM
BID DIVISION HFH – 31A: EARTHWORK

SUBMIT PROPOSAL TO: HFH of Douglas County, Minnesota, Inc.
1211 N Nokomis NE, Alexandria, MN 56308

FOR: **Construction of Habitat for Humanity Homes**

EXCLUDED: 1. Cost of initial material testing (by Owner)
2. ALASD Sewer Permit (Habitat will acquire)

INCLUDED: Provide all labor, materials, equipment, and site supervision to complete the site work, excavation, and backfilling as shown and specified, including but not limited to the following technical specification sections: 31 22 00

ALSO INCLUDED:

1. Verify existing site conditions
2. Gravel, rock & sand as required and final grading under slabs, sidewalks, and aprons
3. Backfilling and compaction (including slab excavation and utility install)
4. Erosion control and sweeping of street as needed and/or required
5. 6" Sand fill over foam insulation and heat tubing (house only)
6. Asphalt patching where required
7. Locate all existing utilities
8. All site demolition
9. Plumbing related utilities to building perimeter
10. All necessary permits and inspections
11. Coordination with other trades
12. This project is managed by Habitat. All contractors on this project are considered prime contractors. Coordination between trades and volunteers is to be considered part of this work scope.

SUBMITTED BY: _____

The sum of **three-bedroom** home _____ Dollars (\$ _____)

In-kind donation (if applicable) **three-bedroom** home _____ Dollars (\$ _____)

Net cost to Habitat for **three-bedroom** home _____ Dollars (\$ _____)

The sum of **four-bedroom** home _____ Dollars (\$ _____)

In-kind donation (if applicable) **four-bedroom** home _____ Dollars (\$ _____)

Net cost to Habitat for **four-bedroom** home _____ Dollars (\$ _____)

Alternate 1A _____ Dollars (\$ _____)

Name of Bidding Contractor _____

Authorized Signature _____ Title _____ Date _____

SECTION 31 22 00 - EARTHWORK

SCOPE OF WORK

Work under this Section shall include, but is not limited to:

- Site clearing, topsoil stripping, stockpiling of topsoil on the site, excavation, installation of fill and backfill, the redistribution of topsoil and other satisfactory soils for filling and finish grading as required, and the compaction of soils, to accommodate work to be performed by others in connection with this project.
- Home with attached garage will be constructed on a Footing/Foundation slab with a footprint as per blueprint.
- Coordinate excavation to accommodate concrete and related work to be provided by others.
- Excavation shall be provided as required for placement of water lines from city stub to house, and if needed to include a properly placed sleeve for water line to enter house.
- Contractor shall include all materials and labor as required to make a sewer connection.
- Contractor shall furnish and install all erosion control materials and perform needed erosion control measures as required by rule and best practices.
- Earthwork shall include cost of removing excess soil and waste material including unsatisfactory soil, trash, and debris, and legally disposing of it off the Owner's property.
- Contractor shall furnish and install at least 6" deep of base material on driveway, including parking area for vehicles, and turnarounds if needed as well as base material for sidewalks.
- The under-floor insulation layer will require that 6" of fill be placed on top of poly and insulation thereby requiring fill to be "swung in" and manually compacted. (Not a requirement in REA's territory)
- Note the requirement for 4" drainage layer under all footings and under entire house (but not under garage floor); this drainage layer to be exposed to daylight by way of 4" drainage pipe, length as needed, to be furnished by Bidder.
- **Coordinate water and sewer pipe placement with plumbing contractor.**

ALTERNATE 1A PRICING

- 1A Quote labor and all additional materials needed in the event of working in cold weather conditions or ground frost on the Proposal Bid Form – Section 31 22 00.

END OF SECTION 31 22 00